

VRR Low Roof Rot Ladder Rack Gen 4

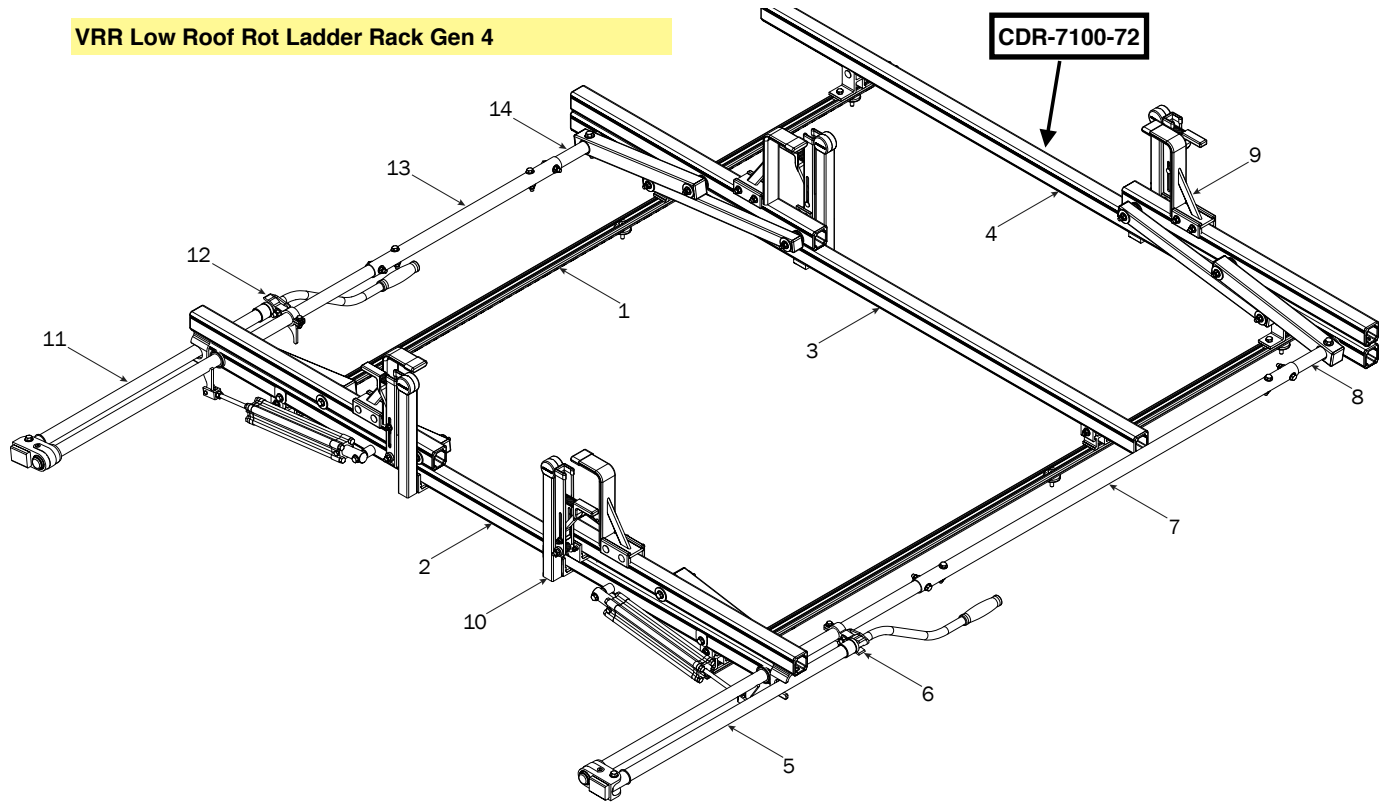

1—FBM3-0010 (Qty 1)
Channels with Hardware

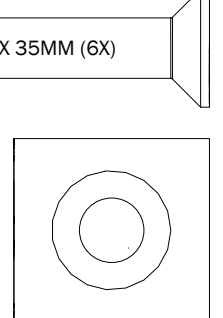
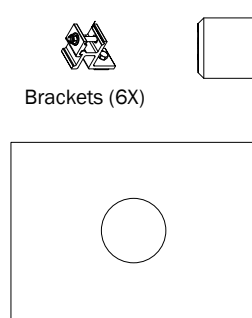
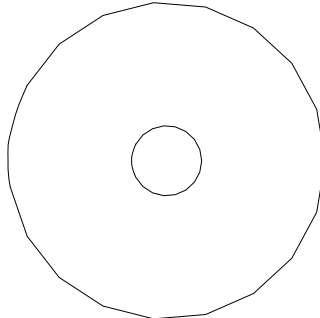
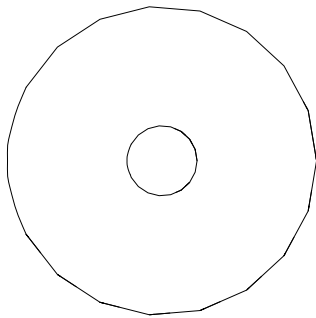

2—Rear Crossbar Assembly (Qty 1)

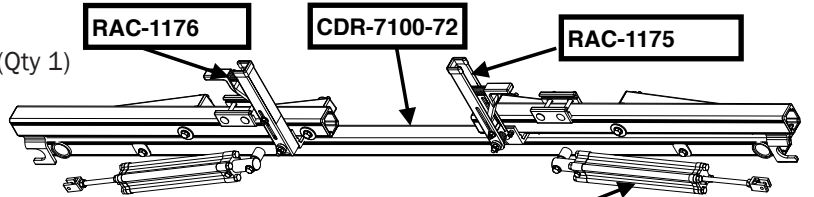

3—Center Crossbar Assembly (Qty 1)

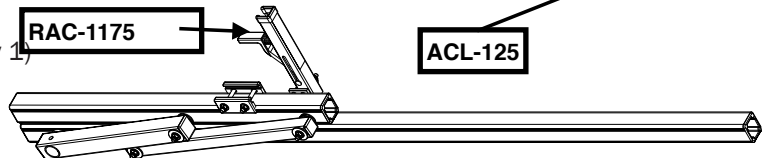

4—Front Crossbar Assembly (Qty 1)

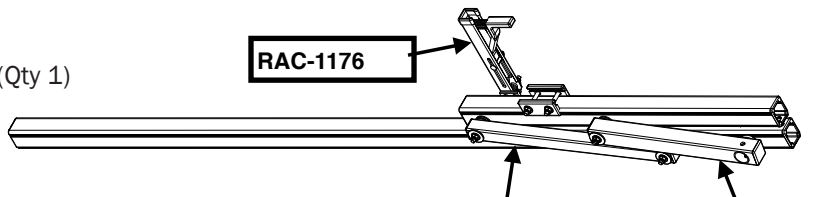

Right Hand, B4 Version, 46.00"

6—Handle Latch Assembly (Qty 1)
Right Hand

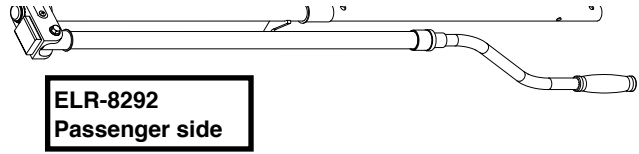

7—Connecting Bar (Qty 1)
4.00'



8—Front Drive Shaft (Qty 1)
B Version, 35.75"

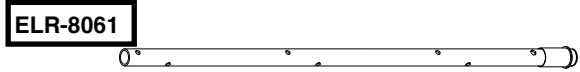

9—Z Post (Qty 4)
Adjustable, 7.25"



10—L Post (Qty 4)
Roller Cap, 9.25"

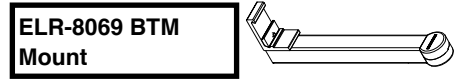

11—Rear Drive Shaft (Qty 1)
Left Hand, B4 Ver, 46.00"

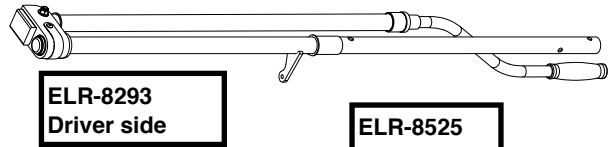

12—Handle Latch Assembly (Qty 1)
Left Hand

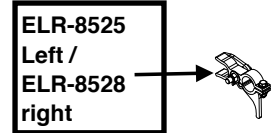

13—Connecting Bar (Qty 1)
24.00"



14—Front Drive Shaft (Qty 1)
B Version, 11.75"

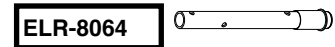

HKT-8162-Rotation Hardware Kit

