

**VRR-326 low roof ladder rack GM**

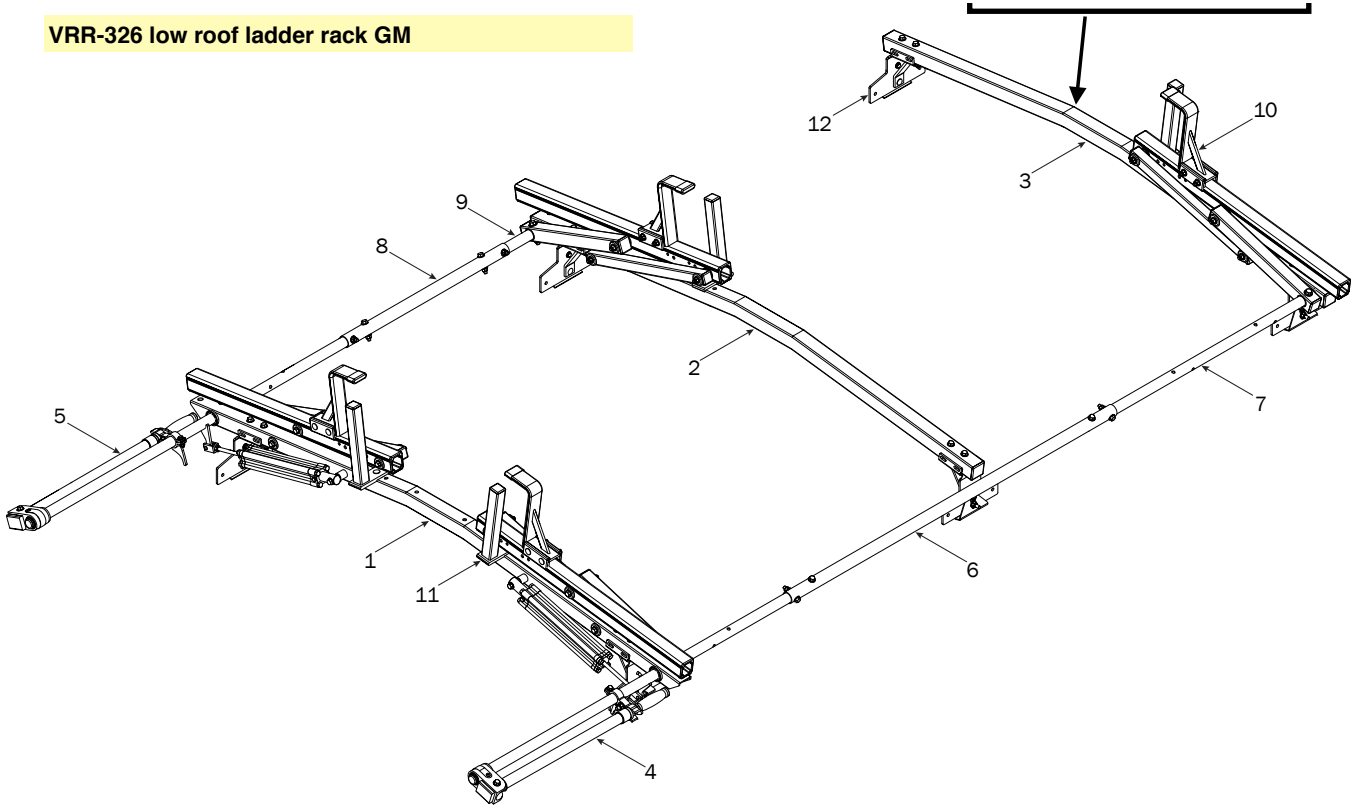

1—Rear Crossbar..... (Qty 1)

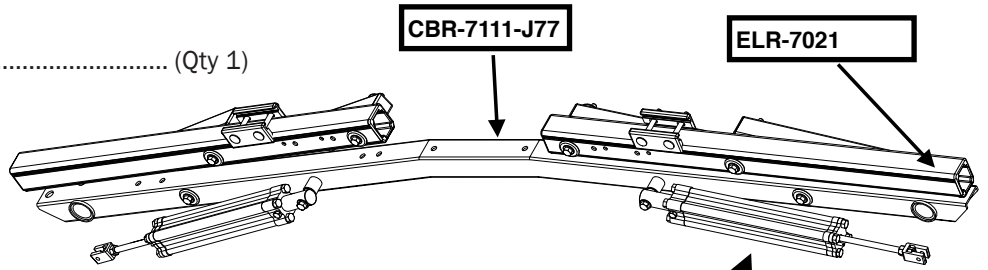

2—Center Crossbar ..... (Qty 1)

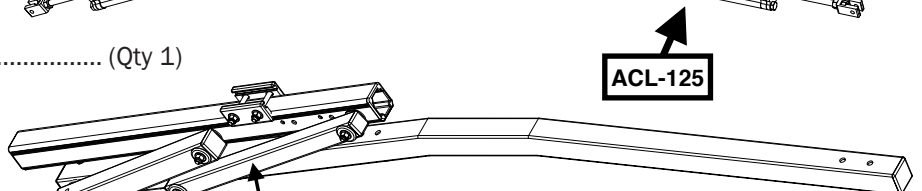

3—Front Crossbar..... (Qty 1)

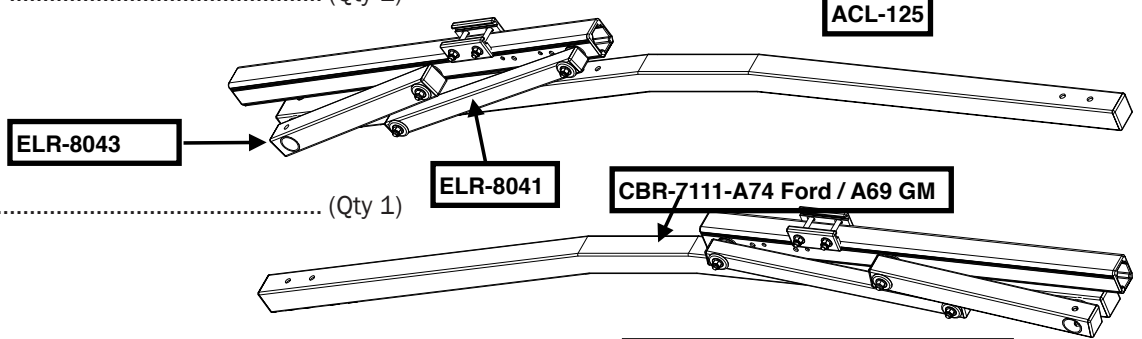

4—Rear Drive Shaft..... (Qty 1)  
Right Hand, B4 Version, 50.00"

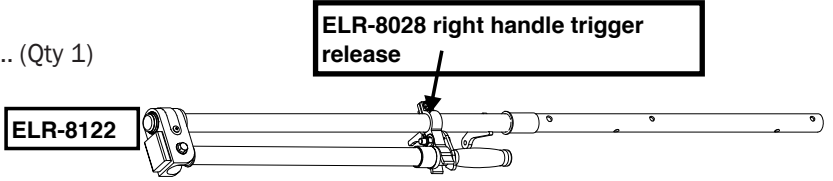

5—Rear Drive Shaft..... (Qty 1)  
Left Hand, B4 Version, 50.00"

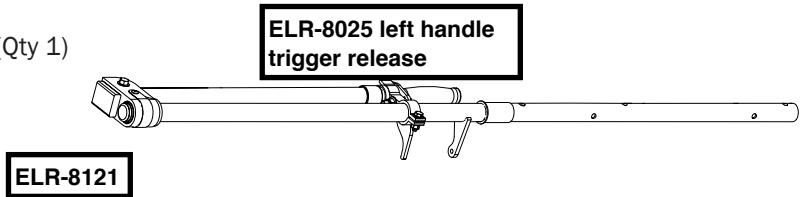

48.00"

**ELR-8204**



7—Front Drive Shaft ..... (Qty 1)  
B Version, 35.75"

**ELR-8061**

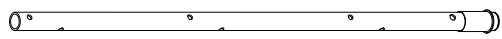

8—Connecting Bar ..... (Qty 1)  
24.00"

**ELR-8202**

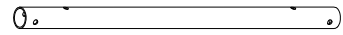

9—Front Drive Shaft ..... (Qty 1)  
B Version, 11.75"

**ELR-8064**

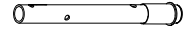

10—Z Post ..... (Qty 4)  
Adjustable, 7.25"

**ELR-8082**

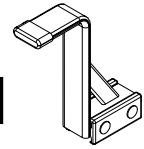

11—L Post ..... (Qty 4)  
9.25"

**ELR-8074**

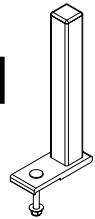

12—Mounting Bracket Assembly ..... (Qty 6)  
Low Mounting, 4.5", GM (Assembly Required)

**BRT-8802 Ford /  
BRT-8803 GM**

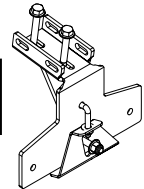

HKT-8140-Rotation Hardware Kit

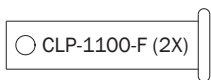

CLP-1100-F (2X)

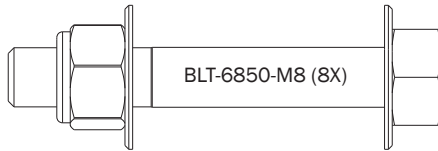

BLT-6850-M8 (8X)



BLT-6822-H (4X)

CTP-1075-B (2X)

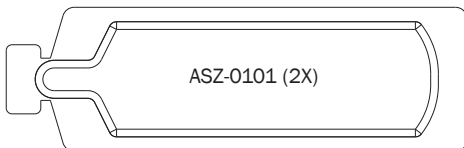

ASZ-0101 (2X)

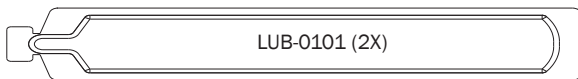

LUB-0101 (2X)

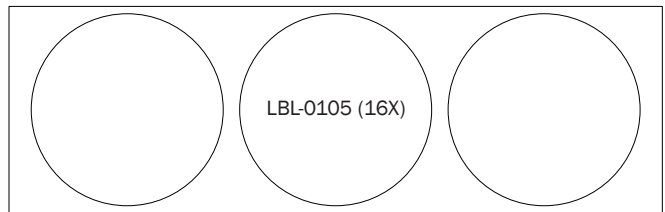

LBL-0105 (16X)